

■ Specifications

- Contact resistance: $\leq 10\text{m}\Omega$
- Insulation resistance: $\geq 1000\text{M}\Omega$
- Rated voltage: 600V AC DC
- Rated current: 23A AC DC
- Withstand voltage: 2200V AC/minute
- Temperature range: $-40^{\circ}\text{C} \sim +105^{\circ}\text{C}$

■ Assembly Layout

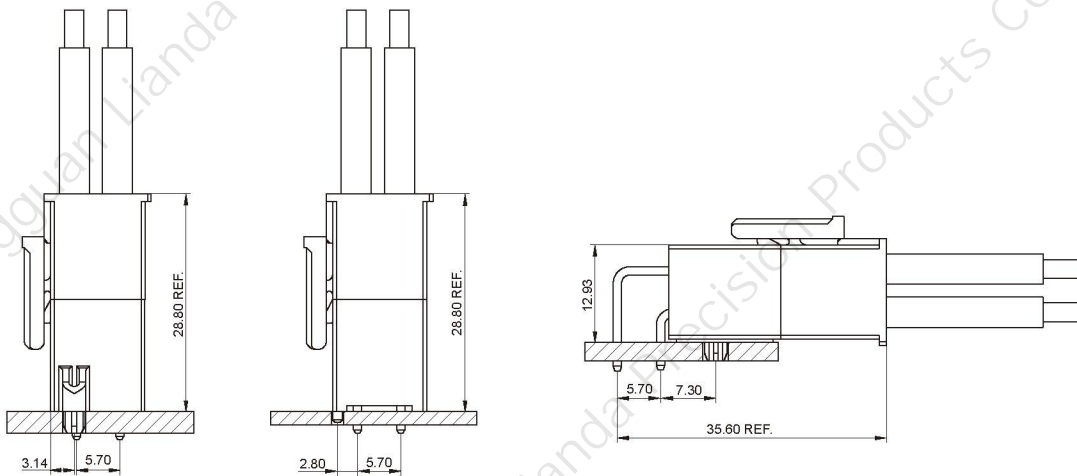

WIRE TO BOARD
BOARD TO BOARD
WIRE TO WIRE
FPC SERIES
THR SERIES
LIGHTING SERIES
OTHER SERIES

A5701 SERIES

5.70mm pitch wire to board connector

A5701A (5.70mm pitch 180°Wafer DIP TYPE)

■ Reference Information:

Material: Pin: High conductivity copper/Tin-plated

Wafer: LCP,UL94V-0

Mates with A5701 series Housing

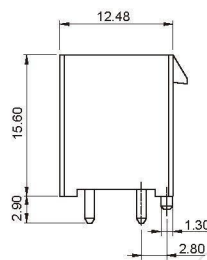
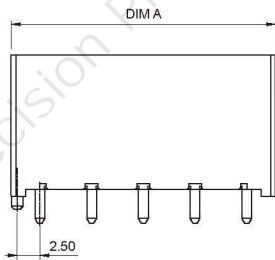
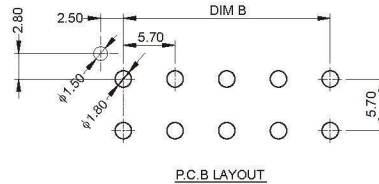
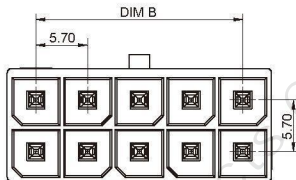
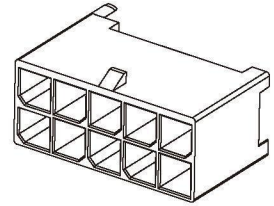

Ordering Information & Dimensions:

Circuit	Dimensions(mm)	
	A	B
2*1	8.35	
2*2	12.05	5.70
2*3	17.78	11.40
2*4	23.45	17.10
2*5	29.15	22.80
2*6	34.85	28.50

A5701AB (5.70mm pitch 180°Wafer DIP TYPE)

■ Reference Information:

Material: Pin:High conductivity copper/Tin-plated

Wafer: LCP,UL94V-0

Mates with A5701 series Housing

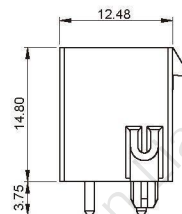
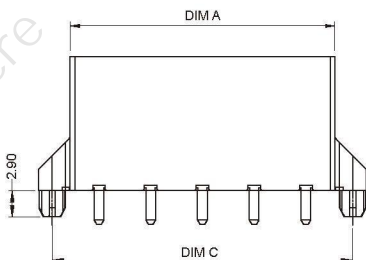
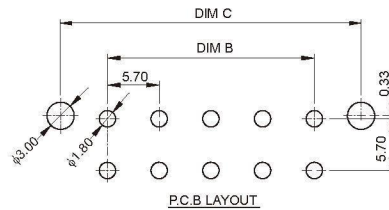
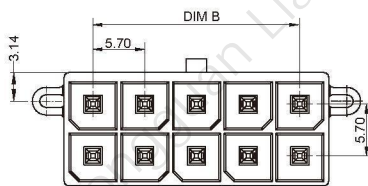
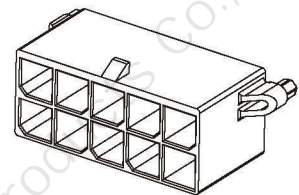

Ordering Information & Dimensions:

Circuit	Dimensions(mm)		
	A	B	C
2*1	8.35		12.34
2*2	12.05	5.70	16.04
2*3	17.78	11.40	21.74
2*4	23.45	17.10	27.44
2*5	29.15	22.80	33.14
2*6	34.85	28.50	38.84

A5701 SERIES

5.70mm pitch wire to board connector

A5701AWB (5.70mm pitch 180°Wafer DIP TYPE)

■ Reference Information:

Material: Pin: High conductivity copper/Tin-plated

Wafer: LCP,UL94V-0

Mates with A5701 series Housing

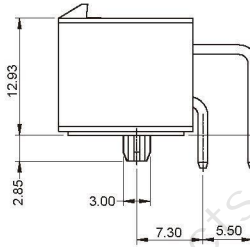
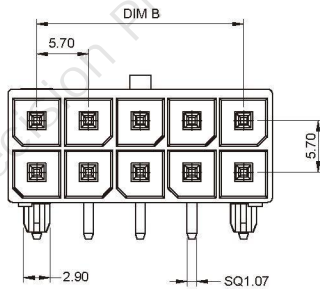
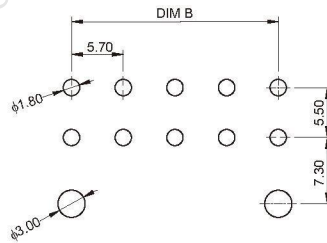
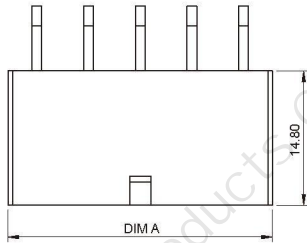
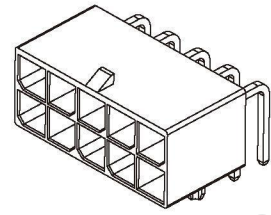

Ordering Information & Dimensions:

Circuit	Dimensions(mm)	
	A	B
2*1	8.35	
2*2	12.05	5.70
2*3	17.78	11.40
2*4	23.45	17.10
2*5	29.15	22.80
2*6	34.85	28.50

A5701Y (5.70mm pitch Housing)

■ Reference Information:

Material: PA66,UL94V-0(2)

Mates with A5701 series Wafer

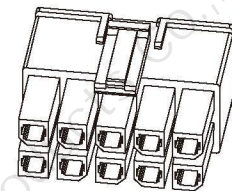
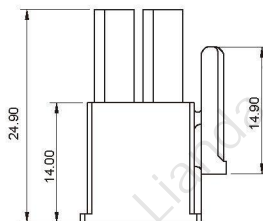
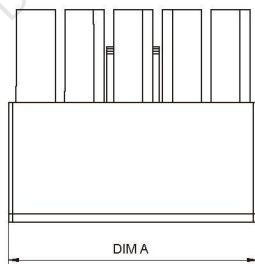
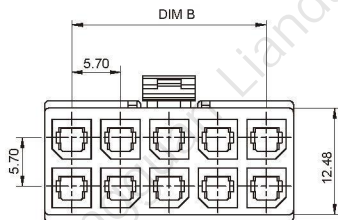

Ordering Information & Dimensions:

Circuit	Dimensions(mm)	
	A	B
2*1	8.35	
2*2	12.05	5.70
2*3	17.78	11.40
2*4	23.45	17.10
2*5	29.15	22.80
2*6	34.85	28.50

A5701 SERIES

5.70mm pitch wire to board connector

A5701T (5.70mm pitch Terminal)

- Reference Information:
Used in A5701 series Housing

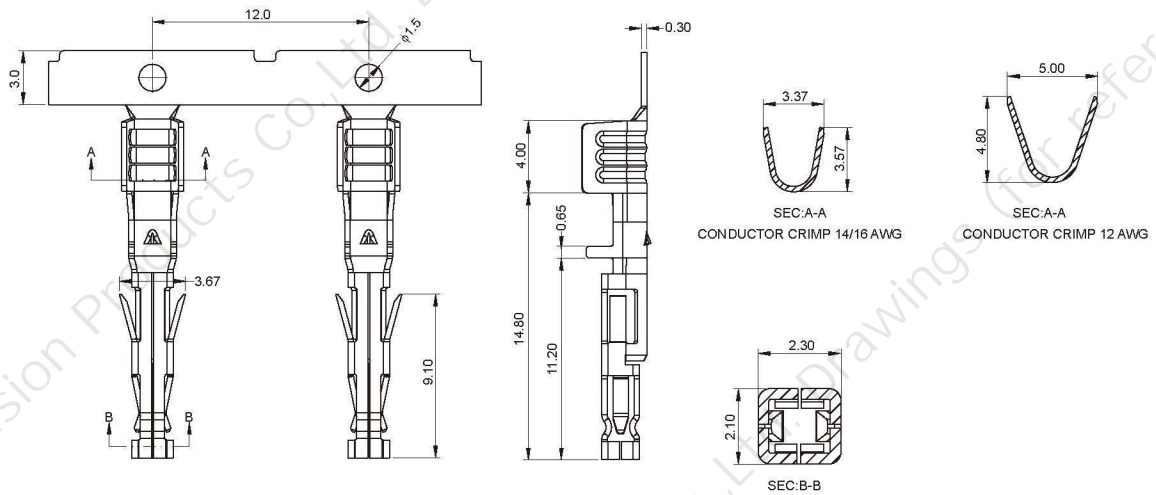

Ordering Information & Dimensions:

Part No	Wire Range	Insulation O.D.	Material	Finish	Qty/Reel
A5701T	AWG #14~#16	1.63mm(max)	High conductivity copper	Tin-plated	/
A5701TG	AWG #12	2.05mm(max)	High conductivity copper	Tin-plated	/