

SPECIFICATION

MATERIAL:

Housing: PBT+30%G. F UL94V-0

Contacts: Copper Alloy

ELECTRICAL:

Current rating: 2 Amps .

Contact resistance: 20 mΩ initial

Insulation resistance: 1000 MΩ min @ 500 VDC

Dielectric withstanding voltage: 1000 VAC/minute

Operating temperature: -55° C TO +125° C

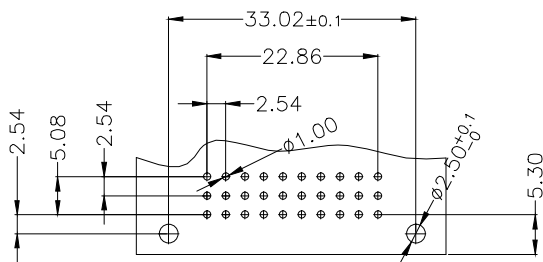
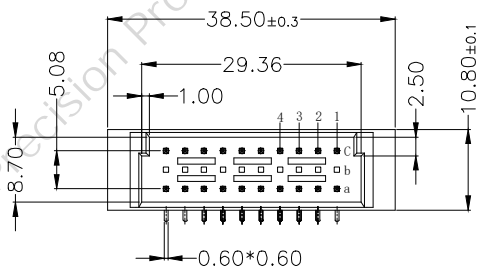
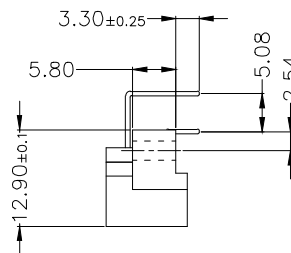
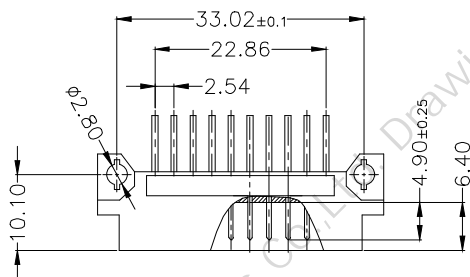

PCB LAYOUT(RECOMMENDED)
(TOP VIEW TOL. :±0.05)

Pitch	Position	Rows with Contacts	Contact Arrange
2.54mm	30	A B C	
	20	A - C	
	10	A - -	
5.08mm	15	A B C	
	10	A - C	
	5	A - -	

公差一览表			
TOLERANCE UNLESS OTHERWISE			
X.	±0.25	X°	±5°
.X	±0.20	.X°	±2°
.XX	±0.15	.XX°	±1°
.XXX	±0.02	.XXX°	±0.5°
日期 Date	2009. 04. 15		

欧式插座DIN 41612 320弯针针座

SPECIFICATION

MATERIAL:

Housing: PBT+30%G. F UL94V-0

Contacts: Copper Alloy

ELECTRICAL:

Current rating: 2 Amps .

Contact resistance: 20 mΩ initial

Insulation resistance: 1000 MΩ min @ 500 VDC

Dielectric withstanding voltage: 1000 VAC/minute

Operating temperature: -55° C TO +125° C

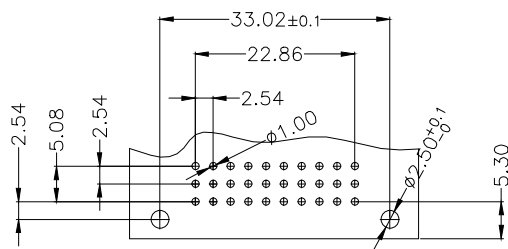
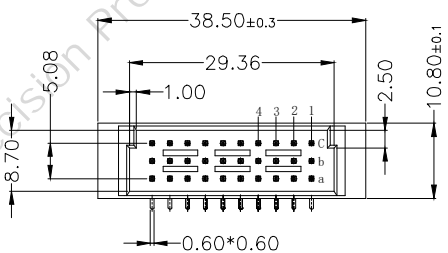
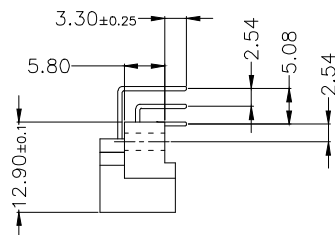
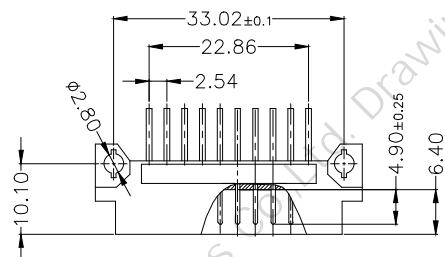

PCB LAYOUT(RECOMMENDED)
(TOP VIEW TOL. :±0.05)

Pitch	Position	Rows with Contacts	Contact Arrange
2.54mm	30	A B C	
	20	A - C	
	10	A - -	
5.08mm	15	A B C	
	10	A - C	
	5	A - -	

公差一览表 TOLERANCE UNLESS OTHERWISE			
X.	±0.25	X°	±5°
.X	±0.20	.X°	±2°
.XX	±0.15	.XX°	±1°
.XXX	±0.02	.XXX°	±0.5°
日期 Date	2009. 04. 15		

欧式插座DIN 41612 330弯针针座

SPECIFICATION

MATERIAL:

Housing: PBT+30%G. F UL94V-0

Contacts: Copper Alloy

ELECTRICAL:

Current rating: 2 Amps .

Contact resistance: 20 mΩ initial

Insulation resistance: 1000 MΩ min @ 500 VDC

Dielectric withstanding voltage: 1000 VAC/minute

Operating temperature: -55° C TO +125° C

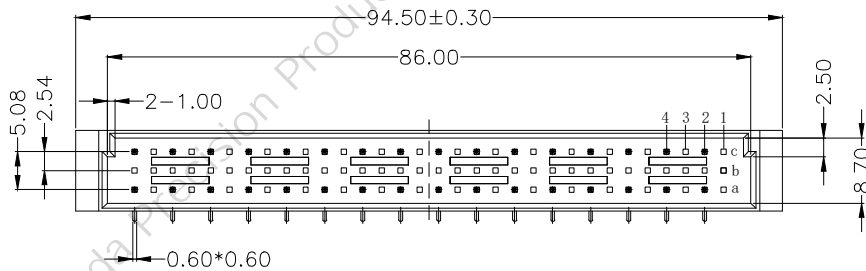
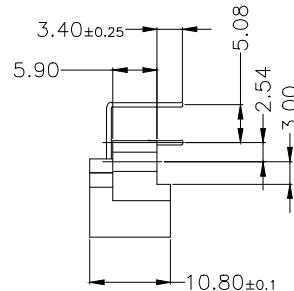
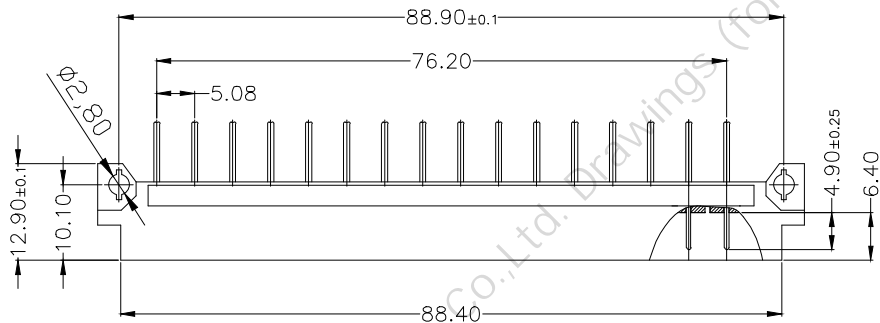

Pitch	Position	Rows with Contacts	Contact Arrange
2.54mm	96	A B C	
	64	A - C	
	32	A - -	
5.08mm	48	A B C	
	32	A - C	
	16	A - -	

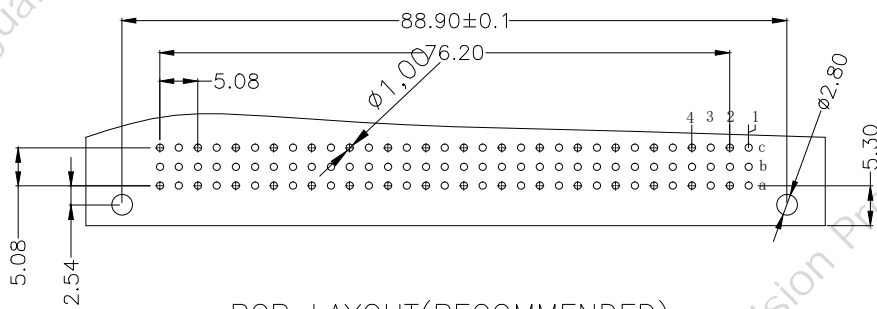

PCB LAYOUT(RECOMMENDED)

(TOP VIEW TOL. :±0.05)

公差一览表			
TOLERANCE UNLESS OTHERWISE			
X.	±0.25	X°.	±5°
.X	±0.20	.X°	±2°
.XX	±0.15	.XX°	±1°
.XXX	±0.02	.XXX°	±0.5°
日期 Date	2009. 04. 15		

欧式插座DIN 41612 332弯针针座-5.08

SPECIFICATION

MATERIAL:

Housing: PBT+30%G. F UL94V-0
 Contacts: Copper Alloy

ELECTRICAL:

Current rating: 2 Amps .
 Contact resistance: 20 mΩ initial
 Insulation resistance: 1000 MΩ min @ 500 VDC
 Dielectric withstanding voltage: 1000 VAC/minute
 Operating temperature: -55° C TO +125° C

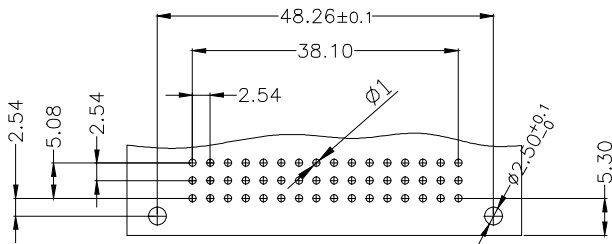
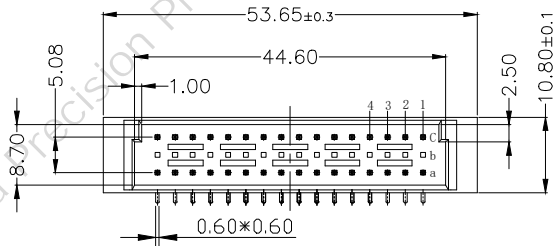
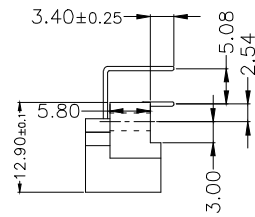
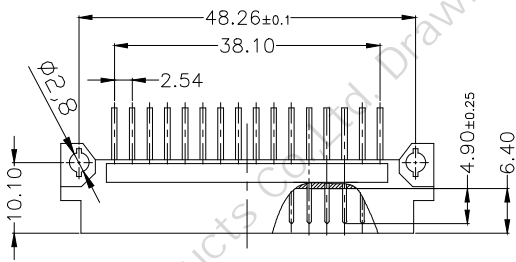

PCB LAYOUT(RECOMMENDED)
 (TOP VIEW TOL. :±0.05)

Pitch	Position	Rows with Contacts	Contact Arrange
2.54mm	48	A B C	
	32	A - C	
	16	A - -	
5.08mm	24	A B C	
	16	A - C	
	8	A - -	

公差一览表 TOLERANCE UNLESS OTHERWISE			
X.	±0.25	X°	±5°
.X	±0.20	.X°	±2°
.XX	±0.15	.XX°	±1°
.XXX	±0.02	.XXX°	±0.5°
日期 Date	2009. 04. 15		

欧式插座DIN 41612 332弯针针座

SPECIFICATION

MATERIAL:

Housing: PBT+30%G. F UL94V-0
 Contacts: Copper Alloy

ELECTRICAL:

Current rating: 2 Amps .
 Contact resistance: 20 mΩ initial
 Insulation resistance: 1000 MΩ min @ 500 VDC
 Dielectric withstanding voltage: 1000 VAC/minute
 Operating temperature: -55° C TO +125° C

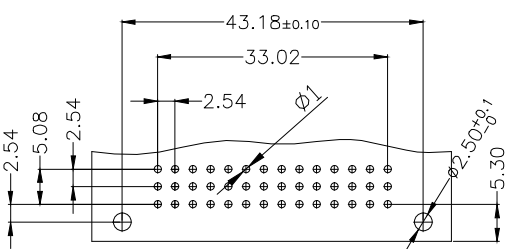
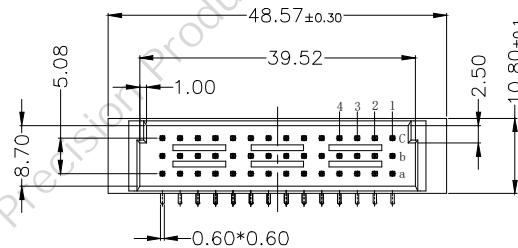
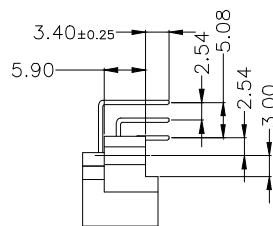
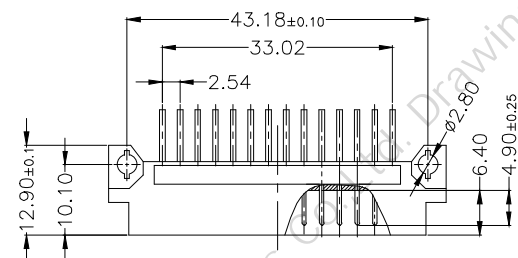

Pitch	Position	Rows with Contacts	Contact Arrange
2.54mm	42	A B C	
	28	A - C	
	14	A - -	
5.08mm	21	A B C	
	14	A - C	
	7	A - -	

PCB LAYOUT(RECOMMENDED)
 (TOP VIEW TOL. :±0.05)

公差一览表 TOLERANCE UNLESS OTHERWISE			
X.	±0.25	X°.	±5°
.X	±0.20	.X°	±2°
.XX	±0.15	.XX°	±1°
.XXX	±0.02	.XXX°	±0.5°
日期 Date	2009. 04. 15		

欧式插座DIN 41612 342弯针针座

SPECIFICATION

MATERIAL:

Housing: PBT+30%G. F UL94V-0

Contacts: Copper Alloy

ELECTRICAL:

Current rating: 2 Amps .

Contact resistance: 20 mΩ initial

Insulation resistance: 1000 MΩ min @ 500 VDC

Dielectric withstanding voltage: 1000 VAC/minute

Operating temperature: -55° C TO +125° C

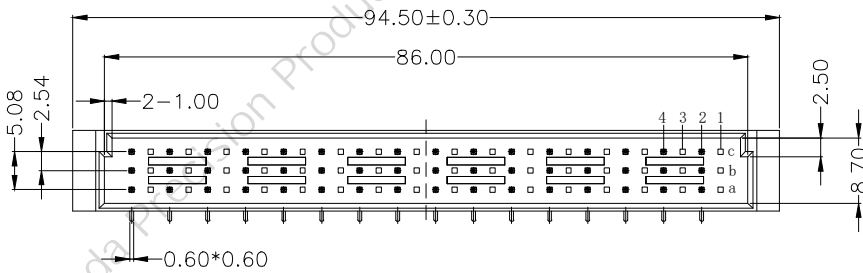
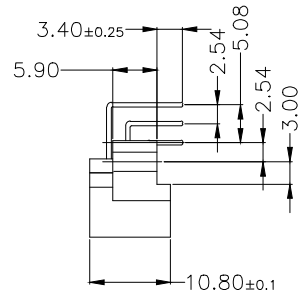
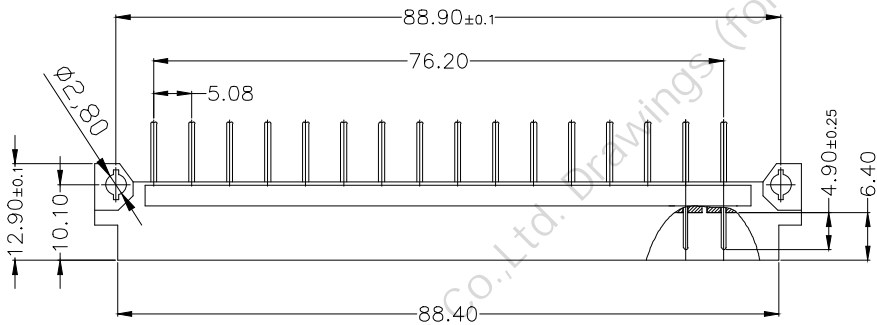

Pitch	Position	Rows with Contacts	Contact Arrange
2.54mm	96	A B C	
	64	A - C	
	32	A - -	
5.08mm	48	A B C	
	32	A - C	
	16	A - -	

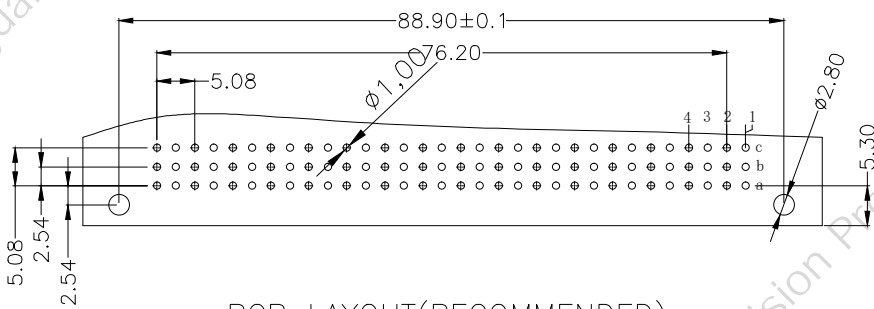

PCB LAYOUT(RECOMMENDED)

(TOP VIEW TOL. :±0.05)

公差一览表			
TOLERANCE UNLESS OTHERWISE			
X.	±0.25	X°.	±5°
.X	±0.20	.X°	±2°
.XX	±0.15	.XX°	±1°
.XXX	±0.02	.XXX°	±0.5°
日期 Date	2009. 04. 15		

欧式插座DIN 41612 348弯针针座-5.08

SPECIFICATION

MATERIAL:

Housing: PBT+30%G. F UL94V-0
 Contacts: Copper Alloy

ELECTRICAL:

Current rating: 2 Amps .
 Contact resistance: 20 mΩ initial
 Insulation resistance: 1000 MΩ min @ 500 VDC
 Dielectric withstanding voltage: 1000 VAC/minute
 Operating temperature: -55° C TO +125° C

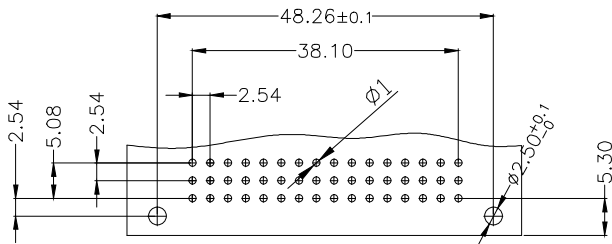
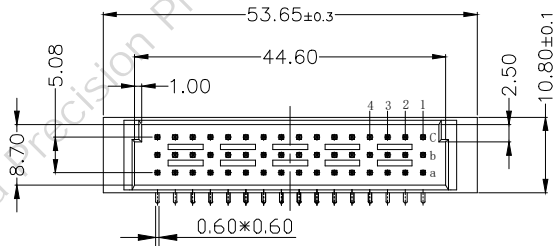
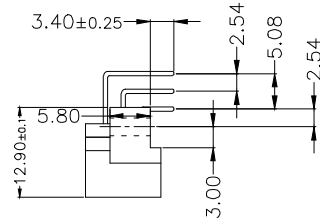
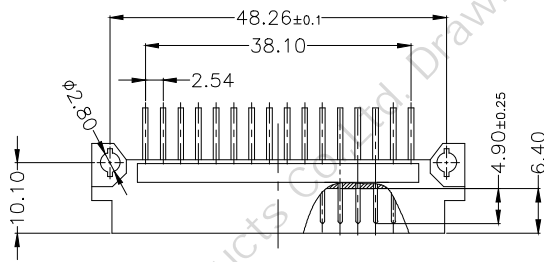

PCB LAYOUT(RECOMMENDED)
 (TOP VIEW TOL. :±0.05)

Pitch	Position	Rows with Contacts	Contact Arrange
2.54mm	48	A B C	
	32	A - C	
	16	A - -	
5.08mm	24	A B C	
	16	A - C	
	8	A - -	

公差一览表 TOLERANCE UNLESS OTHERWISE			
X.	±0.25	X°	±5°
.X	±0.20	.X°	±2°
.XX	±0.15	.XX°	±1°
.XXX	±0.02	.XXX°	±0.5°
日期 Date	2009. 04. 15		

欧式插座DIN 41612 348弯针针座

SPECIFICATION

MATERIAL:

Housing: PBT+30%G. F UL94V-0

Contacts: Copper Alloy

ELECTRICAL:

Current rating: 2 Amps .

Contact resistance: 20 mΩ initial

Insulation resistance: 1000 MΩ min @ 500 VDC

Dielectric withstanding voltage: 1000 VAC/minute

Operating temperature: -55° C TO +125° C

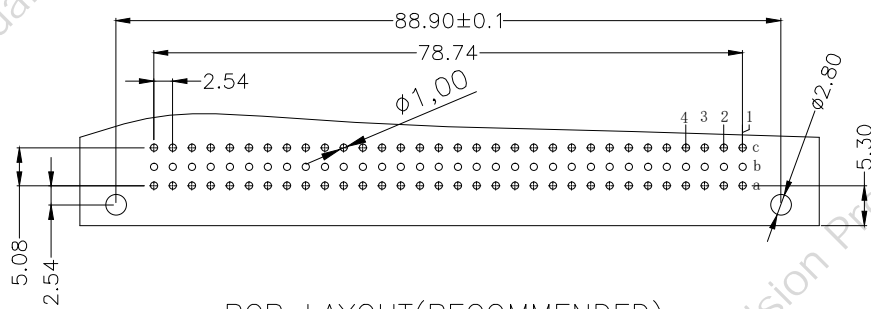
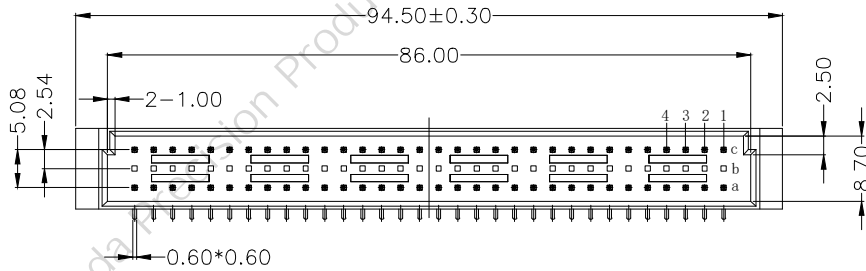
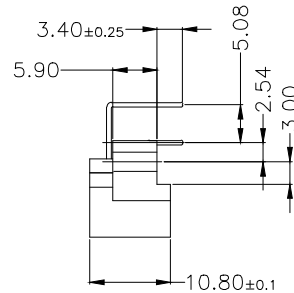
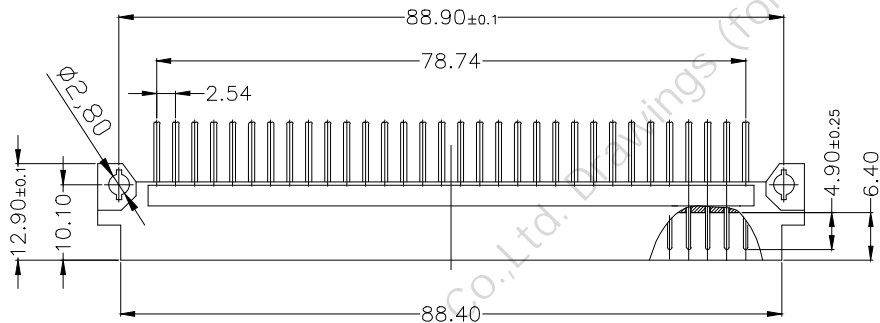

PCB LAYOUT(RECOMMENDED)

(TOP VIEW TOL. :±0.05)

Pitch	Position	Rows with Contacts	Contact Arrange
2.54mm	96	A B C	
	64	A - C	
	32	A - -	
5.08mm	48	A B C	
	32	A - C	
	16	A - -	

公差一览表			
TOLERANCE UNLESS OTHERWISE			
X.	±0.25	X°.	±5°
.X	±0.20	.X°.	±2°
.XX	±0.15	.XX°.	±1°
.XXX	±0.02	.XXX°.	±0.5°
日期 Date	2009. 04. 15		

欧式插座DIN 41612 364弯针针座

SPECIFICATION

MATERIAL:

Housing: PBT+30%G. F UL94V-0
 Contacts: Copper Alloy

ELECTRICAL:

Current rating: 2 Amps .
 Contact resistance: 20 mΩ initial
 Insulation resistance: 1000 MΩ min @ 500 VDC
 Dielectric withstanding voltage: 1000 VAC/minute
 Operating temperature: -55° C TO +125° C

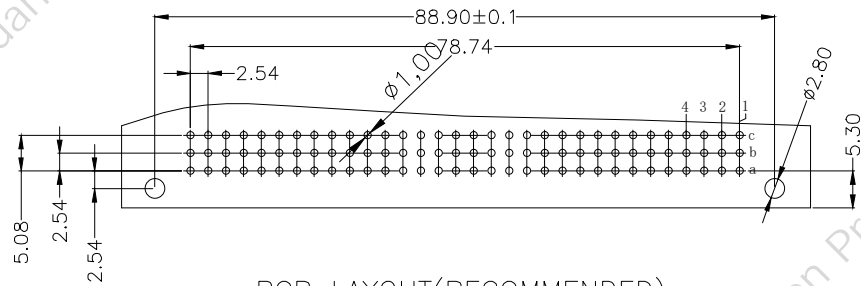
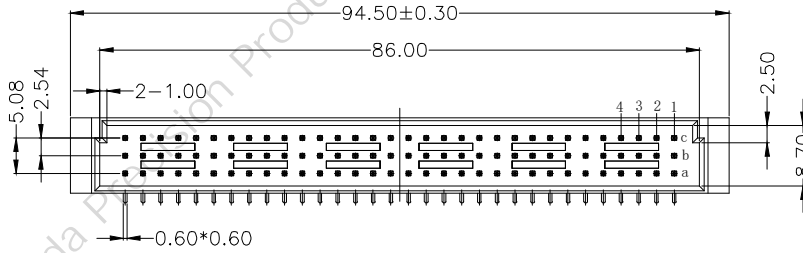
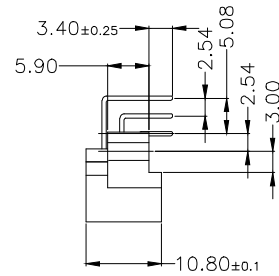
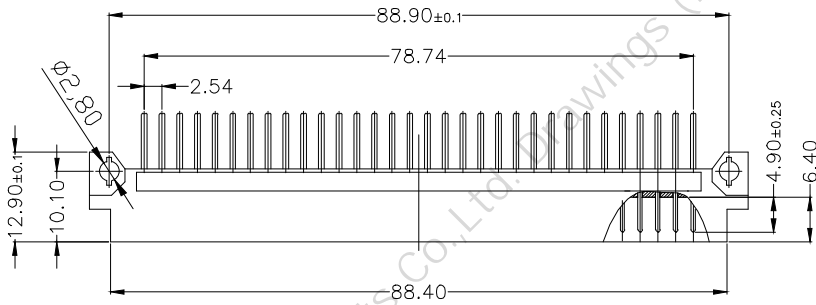

Pitch	Position	Rows with Contacts	Contact Arrange
2.54mm	96	A B C	
	64	A - C	
	32	A - -	
5.08mm	48	A B C	
	32	A - C	
	16	A - -	

PCB LAYOUT(RECOMMENDED)
 (TOP VIEW TOL. :±0.05)

公差一览表 TOLERANCE UNLESS OTHERWISE			
X.	±0.25	X°.	±5°
.X	±0.20	.X°	±2°
.XX	±0.15	.XX°	±1°
.XXX	±0.02	.XXX°	±0.5°
日期 Date	2009. 04. 15		

欧式插座DIN 41612 396弯针针座

SPECIFICATION

MATERIAL:

Housing: PBT+30%G. F UL94V-0

Contacts: Copper Alloy

ELECTRICAL:

Current rating: 2 Amps .

Contact resistance: 20 mΩ initial

Insulation resistance: 1000 MΩ min @ 500 VDC

Dielectric withstanding voltage: 1000 VAC/minute

Operating temperature: -55° C TO +125° C

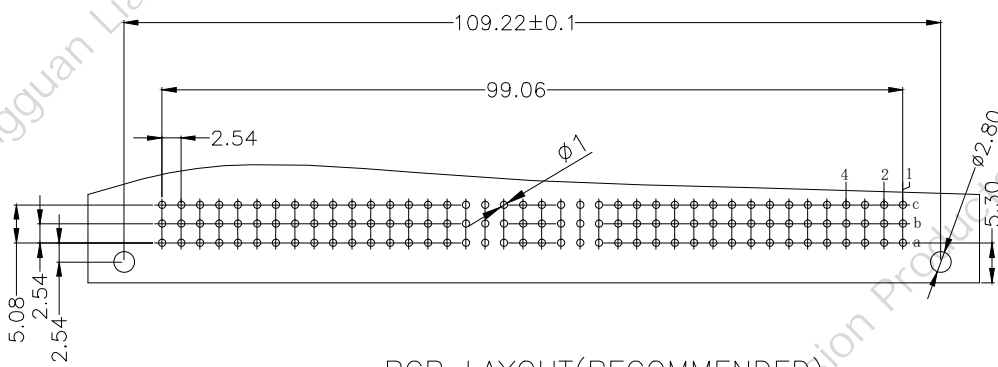
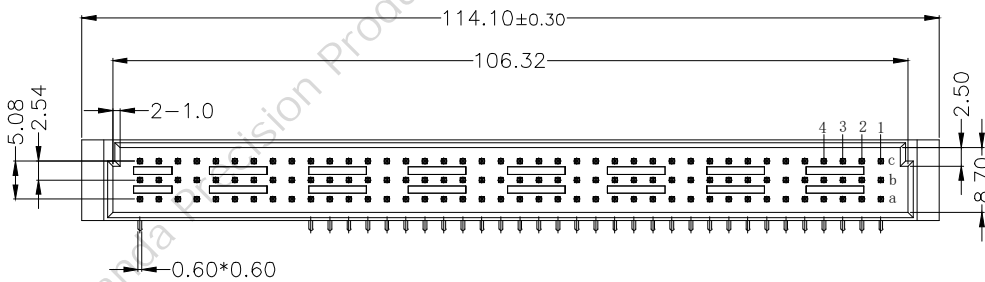
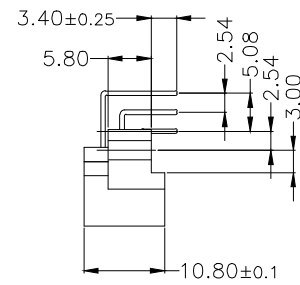
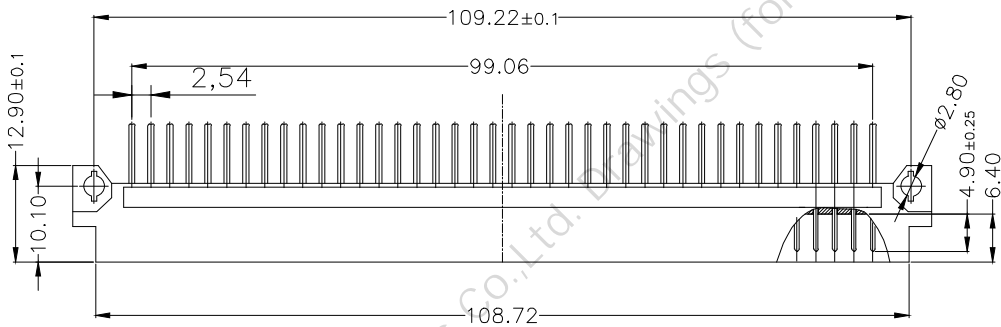

PCB LAYOUT(RECOMMENDED)

(TOP VIEW TOL. :±0.05)

Pitch	Position	Rows with Contacts	Contact Arrange
2.54mm	120	A B C	
	80	A - C	
	40	A - -	
5.08mm	60	A B C	
	40	A - C	
	20	A - -	

公差一览表			
TOLERANCE UNLESS OTHERWISE			
X.	±0.25	X°.	±5°
.X	±0.20	.X°	±2°
.XX	±0.15	.XX°	±1°
.XXX	±0.02	.XXX°	±0.5°
日期 Date	2009. 04. 15		

欧式插座DIN 41612 3120弯针针座