

NOTES:

MATERIAL:

1. HOUSING: THERMO-PLASTIC. UL 94V-0 NATURE

2. CONTACT: COPPER ALLOY

CONTACT: SEE ORDER INFORMATION;

SOLDER: 10u" GOLD IN CONTACT AREA, MATTE TIN ON TAIL

ELECTRICAL:

1. CURRENT RATING: 60 A MAX

2. WITHSTANDING VOLTAGE: 600V AC for 1 min

3. INSULATION RESISTANCE: 1000MΩ MIN

ENVIRONMENTAL:

1. OPERATING TEMPERATURE: -55°C TO +125°C.

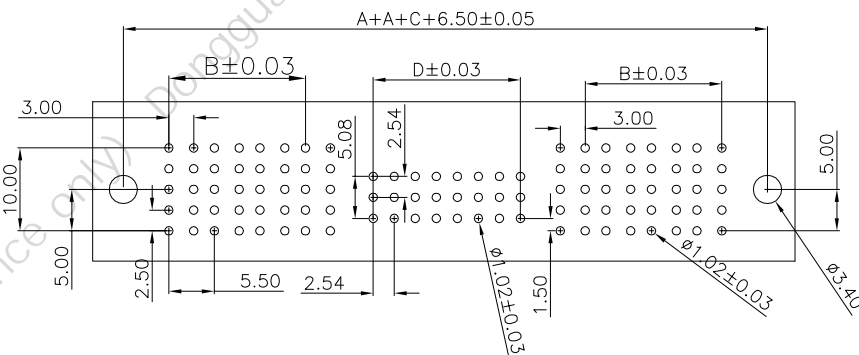
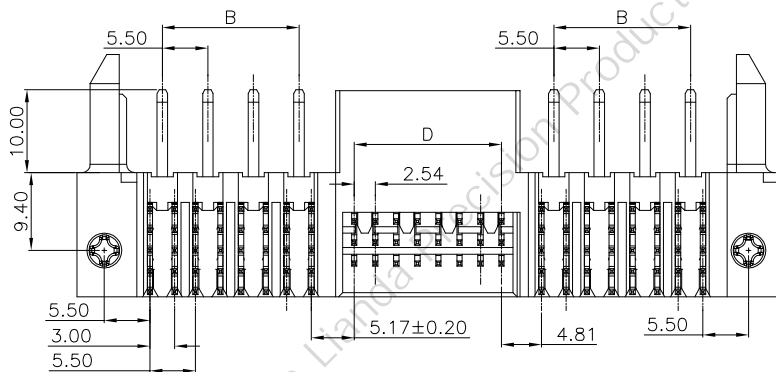
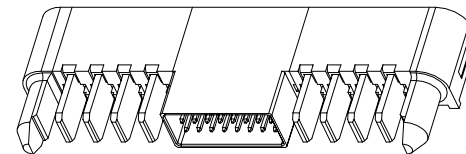

Recommended PC board pattern
(TOP VIEW)

TAIL	E	F
1	2.84	2.84
2	3.61	3.41

SIGNAL	C	D
06	8.02	2.54
12	13.10	7.62
18	18.18	12.70
24	23.26	17.78
30	28.34	22.86
36	33.42	27.94

POWER	A	B
01	7.50	N/A
02	13.00	5.50
03	18.50	11.00
04	24.00	16.50
05	29.50	22.00
06	35.00	27.50
07	40.50	33.00
08	46.00	38.50
09	51.50	44.00
10	57.00	49.50

ET60T 弯式公座

RoHS Compliant
2013/05/EC



一般公差	
GENERAL TOLERANCE	
.I	±0.35
.II	±0.25
.III	±0.10
ANGLES	±1°

修订 SER	修改摘要 REVISION DESCRIPTION	签名 SIGNATURE	日期 DATE

版本 (REV)	
A	

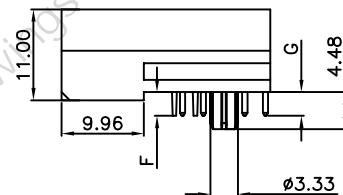
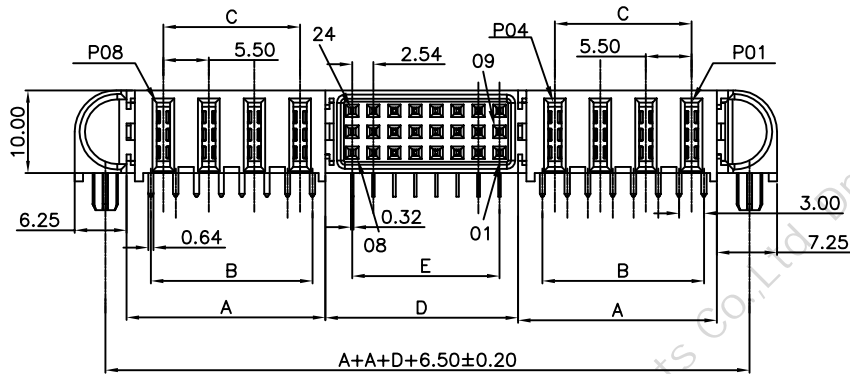

NOTES:

MATERIAL:

- 1. HOUSING: THERMO-PLASTIC. UL 94V-0 NATURE
- 2. CONTACT: COPPER ALLOY
- CONTACT: SEE ORDER INFORMATION;
- SOLDER: 10u" GOLD IN CONTACT AREA, MATTE TIN ON TAIL

ELECTRICAL:

- 1. CURRENT RATING: 60 A MAX
- 2. WITHSTANDING VOLTAGE: 600V AC for 1 min
- 3. INSULATION RESISTANCE: 1000MΩ MIN

ENVIRONMENTAL:

- 1. OPERATING TEMPERATURE: -55°C TO +125°C.

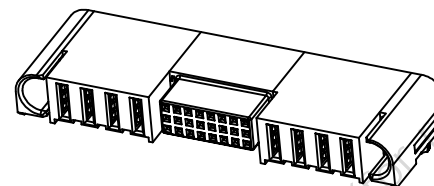

TAIL	F	G
1	2.84	2.84
2	3.61	3.41

SIGNAL	D	E
06	8.02	2.54
12	13.10	7.62
18	18.18	12.70
24	23.26	17.78
30	28.34	22.86
36	33.42	27.94

POWER	A	B	C
01	7.50	N/A	N/A
02	13.00	8.50	5.50
03	18.50	14.00	11.00
04	24.00	19.50	16.50
05	29.50	25.00	22.00
06	35.00	30.50	27.50
07	40.50	36.00	33.00
08	46.00	41.50	38.50
09	51.50	47.00	44.00
10	57.00	52.50	49.50

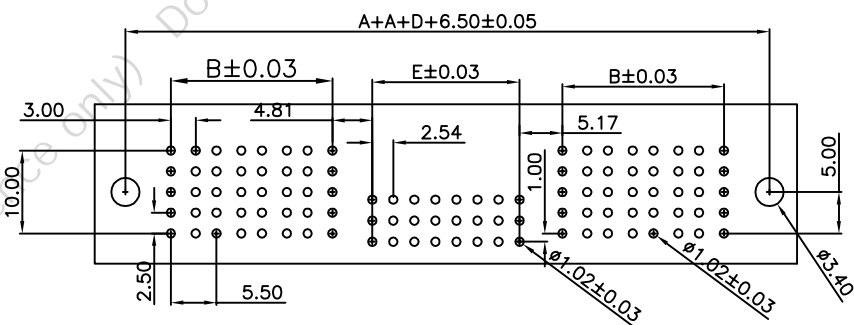
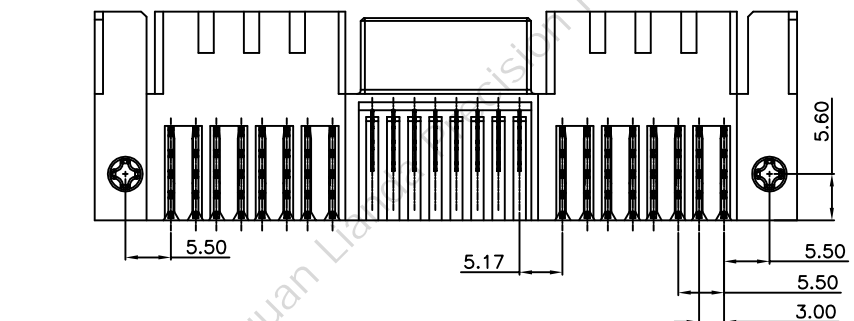

Recommended PC board pattern
(TOP VIEW)

ET60S弯式母座



修订 SER	修改摘要 REVISION DESCRIPTION	签名 SIGNATURE	日期 DATE	版本 (REV)	版本 (REV)
				A	

一般公差 GENERAL TOLERANCE	
.X	±0.35
.XX	±0.25
.XXX	±0.10
ANGLES	±1°

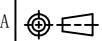

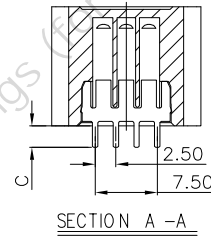
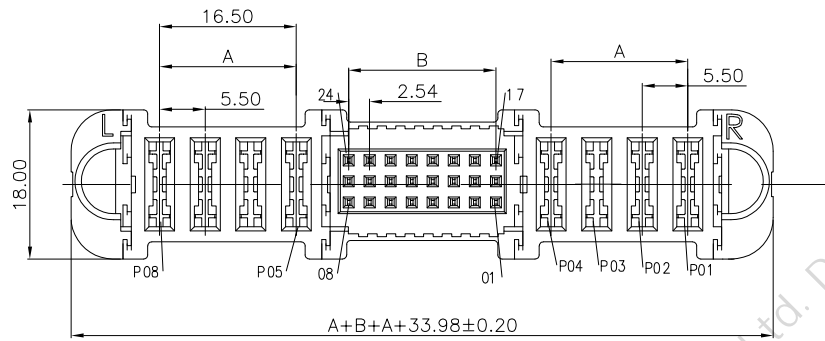

NOTES:

MATERIAL:

- 1.HOUSING:THERMO-PLASTIC. UL 94V-0 NATURE
- 2.CONTACT:COPPER ALLOY
- CONTACT:SEE ORDER INF ORMATION;
- SOLDER:10 μ " GOLD IN CONTACT AREA, MATTE TIN ON TAIL

ELECTRICAL:

- 1.CURRENT RATING:60 A MAX
- 2.WITHSTANDING VOLTAGE:600V AC for 1 min
- 3.INSULATION RESISTANCE:1000M Ω MIN

ENVIRONMENTAL:

- 1. OPERATING TEMPERATURE:-55°C TO +125°C.

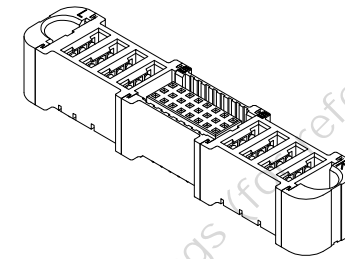
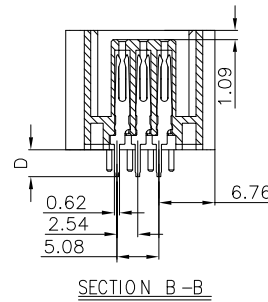
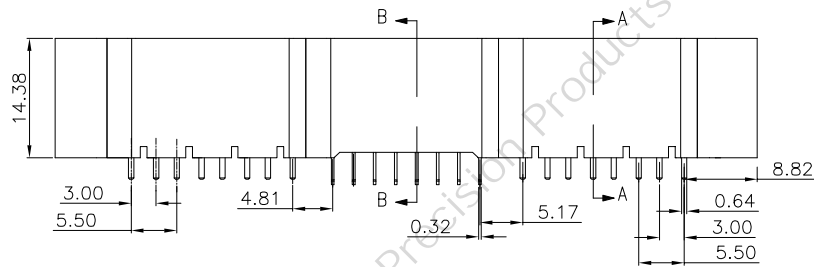

TAIL	C	D
1	2.60	3.28
2	2.83	3.28

SIGNAL	B
06	2.54
12	7.62
18	12.70
24	17.78
30	22.86
36	27.94

POWER	A
01	N/A
02	5.50
03	11.00
04	16.50
05	22.00
06	27.50
07	33.00
08	38.50
09	44.00
10	49.50

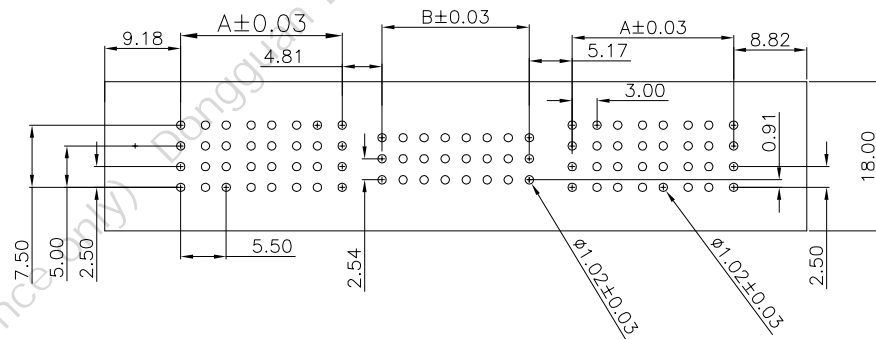

Recommended PC board pattern
(TOP VIEW)

ET60S 直式母座

RoHS Compliant
2013/05/EC



一般公差	
GENERAL TOLERANCE	
.I	±0.35
.II	±0.25
.III	±0.10
ANGLES	±1°

修订 SER	修改摘要 REVISION DESCRIPTION	签名 SIGNATURE	日期 DATE	版本 (REV)

