

REV	ECN NO	DESCRIPTION	DATE	NAME
A		NEW	05/13-'22	LZR

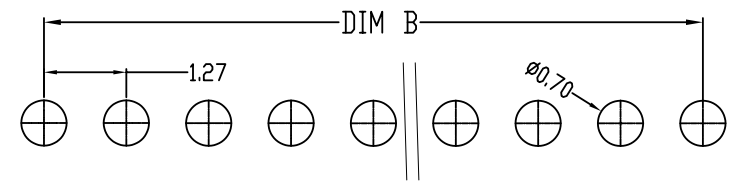
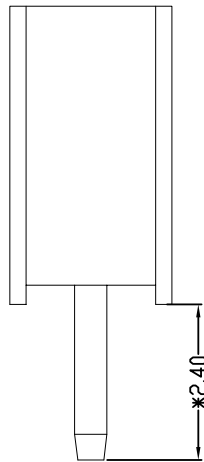
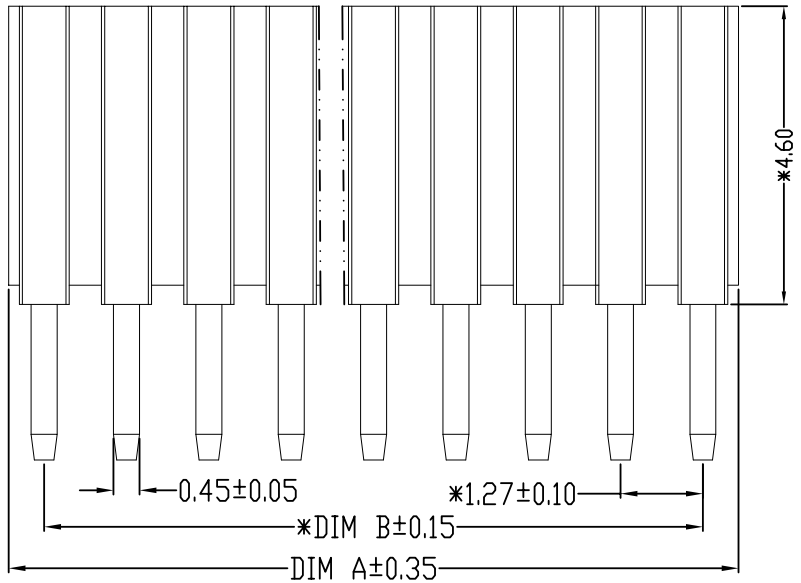
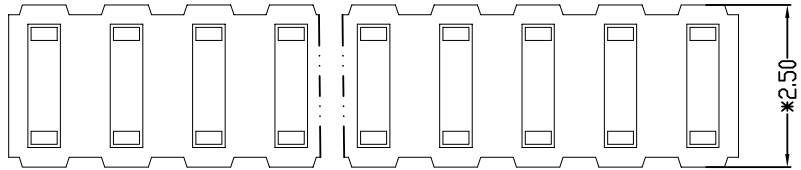

PCB LAYOUT

Specifications

- 规范
- Current Rating: 1.0Amps
额定电流:1.0安培
 - rated voltage: 125V AC/DC
额定电压:125V AC/DC
 - Insulation Resistance: 1000 MΩ Min
绝缘电阻:最小1000 MΩ
 - Dielectric withstanding Voltage: 500V AC
耐电压:500V AC
 - Contact Resistance: 20 mΩ Max
接触电阻:最大20 mΩ
 - Operating Temperature: -40° C to+105° C
工作温度:-40° C ~+105° C
 - Contact Material: Phosphor Bronze
接触材质:磷铜
 - Plating: Au G/F
电镀:金 G/F
 - Insulation Material: PA6T, UL94V-0
绝缘材料:PA6T, UL94V-0
 - Marked "*" symbol are major dimensions
标有 "*" 符号为主要尺寸
 - Packing: 500Bag+Box;
包装: 500袋+盒;

PIN	DIM A	DIM B
1x1P	1.67	
1x2P	2.94	1.27
1x3P	4.21	2.54
1x4P	5.48	3.81
1x5P	6.75	5.08
1x6P	8.02	6.35
1x7P	9.29	7.62
1x8P	10.56	8.89
1x9P	11.83	10.16
1x10P	13.10	11.43
1x11P	14.37	12.70
1x12P	15.64	13.97
1x13P	16.91	15.24
1x14P	18.18	16.51
1x15P	19.45	17.78
1x16P	20.72	19.05
1x17P	21.99	20.32
1x18P	23.26	21.59
1x19P	24.53	22.86
1x20P	25.80	24.13
1x21P	27.07	25.4
1x22P	28.34	26.67
1x23P	29.61	27.94
1x24P	30.88	29.21
1x25P	32.15	30.48
1x26P	33.42	31.75
1x27P	34.69	33.02
1x28P	35.96	34.29
1x29P	37.23	35.56
1x30P	38.50	36.83
1x31P	39.77	38.10
1x32P	41.04	39.37
1x33P	42.31	40.64
1x34P	43.58	41.91
1x35P	44.85	43.18
1x36P	46.12	44.45
1x37P	47.39	45.72
1x38P	48.66	46.99
1x39P	49.93	48.26
1x40P	51.20	49.53

Ordering Information

LFH 127 X XX X XXXX

Code	Pitch	Rows	PIN Number	Packing	Serial No
FH:FEMALE HEADER 排母	100:1.0 127:1.27 200: 2.0 250:2.5 254: 2.54	1:1Row单排 2:2Row双排 3:3Row三排 (Per Row每排) 4:4Row四排	PIN数 1~99	A:PE Bag 袋装 B:Tube 管装 C:Tray 盘装 D:Reel 卷装 E:Bag and Box 袋加盒 F:Other其他	0001~9999

LDCONN 东莞连大精密制品有限公司
DongGuan LianDa Precision Products Co., LTD

STANDARD TOLERANCE (EXCEPT SPECIFIED)	
LINER	ANGLES
.0 ±0.30	0.° ±3°
.00 ±0.20	.0° ±2°
.000 ±0.10	.00° ±1°

TITLE	PH1.27X4.6 1X6P 180° 单排排母Y型	DRAWN BY	LZR	05/13-'22
PART NO	LFH127106C0001	CHECKED BY	工程 7-11-22 朱磊	
DRAWING NO		APPROVED BY	工程 7-11-22 周晓	
SCALE	1:1	UNIT	mm	PAGE 1/1
				SIZE A4

HSF RoHS

REV	ECN NO	DESCRIPTION	DATE	NAME
A		NEW		

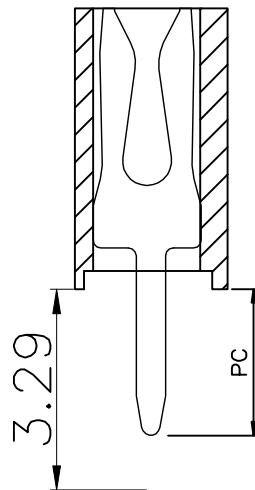
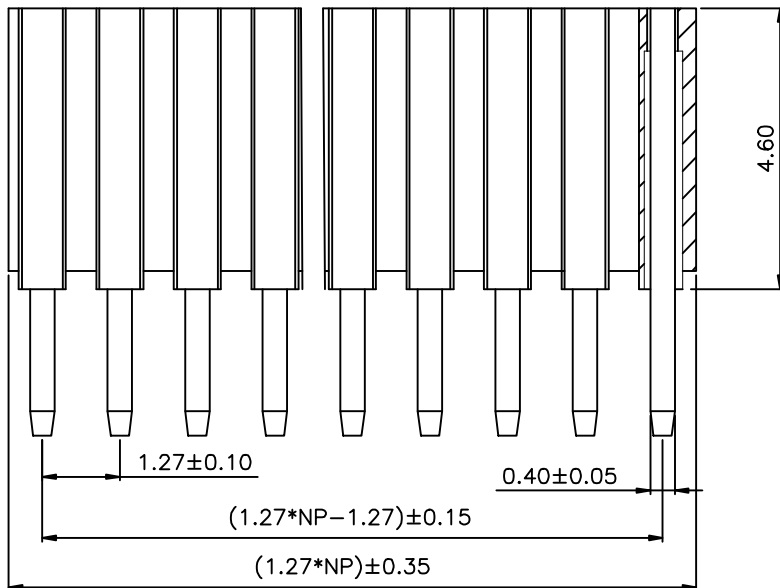
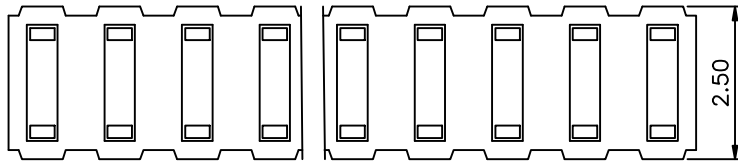

Specifications

1. Current Rating: 1Amps
2. Contact Resistance: 20mΩ
3. Insulator Resistance: 1000 Megohms min.
4. Dielectric withstanding Voltage: AC/DC 500V
5. Operating Temperature: -40°C to +105°C
6. Contact Material: phosphor Bronze
7. Insulator Material: As follows
8. Plated: As follows

Ordering Information

L303 XX -XX 0 X X XX X

Insulation Height*Wide (H*W) Option:	NO. of Pins Per Row: 1-50P	Insulation Material Option:	Contact Plating	Serial NO.	Packing
46=4.6*2.5		1=PBT 2=PPS 3=NY6T 4=LCP 5=NY66 6=Customized 7=NY46 8=NY9T	0=0.8" Gold 1=Au1" Gold 2=Au1.5" Gold 3=Au2" Gold 4=Au3" Gold 5=Au5" Gold 6=Customized 7=Gold/Tin 8=Tin	01-69 (No pillars) 70-89 (pillars) 90-99 (outside pillars)	A=PE Bag B=Tube C=Tray D=Reel

Dimension antitheses list

ITEM	PC		
Standard	1.8/2.4/3.0		
Alternate			

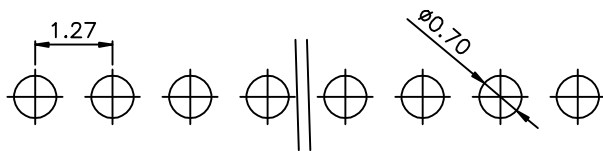

PCB LAYOUT

STANDARD TOLERANCE (EXCEPT SPECIFIED)

LINER		ANGLES	
.0	±0.30	0.°	±3°
.00	±0.20	.0°	±2°
.000	±0.10	.00°	±1°

LDCONN 东莞连大精密制品有限公司

大 DongGuan LianDa Precision Products Co., LTD

TITLE	PH1.27mm H4.6mm 1XNP 180° Single row Female Header Y Type	DRAWN BY	Lujunhui	18.03.30
PART NO	L303XX-XX0XXXXX	CHECKED BY		
DRAWING NO		APPROVED BY		
SCALE	1:1	UNIT	mm	PAGE 1/1
		SIZE	A4	

HSF RoHS

REV	ECN NO	DESCRIPTION	DATE	NAME
A		NEW		

Specifications

- 1.Current Rating:1Amps
- 2.Contact Resistance: 20mΩ
- 3.Insulator Resistance:1000 Megohms min.
- 4.Dielectric withstanding Voltage: AC/DC 500V
- 5.Operating Temperature:-40℃ to+105℃
- 6.Contact Material: phosphor Bronze
- 7.Insulator Material:Asfollows
- 8.Plated: Asfollows

Ordering Information

L303 XX -XX 0 X X XX X

Insulation Height*Wide (H*W) Option:	NO. of Pins Per Row: 1-50P	Insulation Material Option:	Contact Plating	Serial NO.	Packing
85=8. 5*2. 5		1=PBT 2=PPS 3=NY6T 4=LCP 5=NY66 6=Customized 7=NY46 8=NY9T	0=0. 8" Gold 1=Au1" Gold 2=Au1. 5" Gold 3=Au2" Gold 4=Au3" Gold 5=Au5" Gold 6=Customized 7=Gold/Tin 8=Tin	01-69 (No pillars) 70-89 (pillars) 90-99 (outside pillars)	A=PE Bag B=Tube C=Tray D=Reel

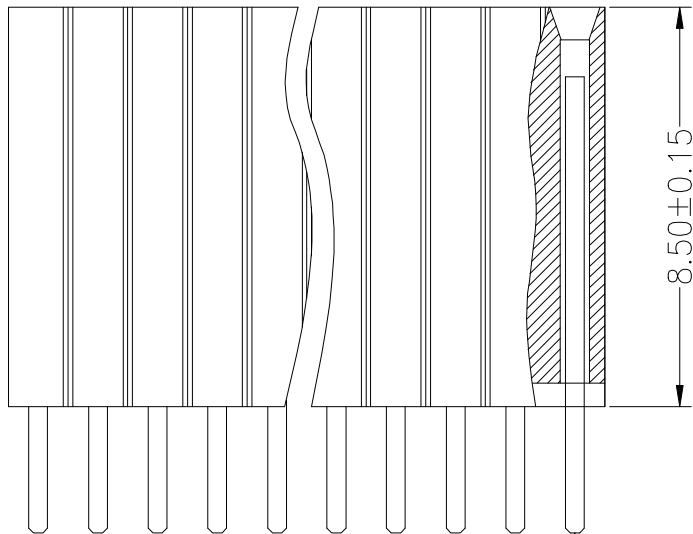
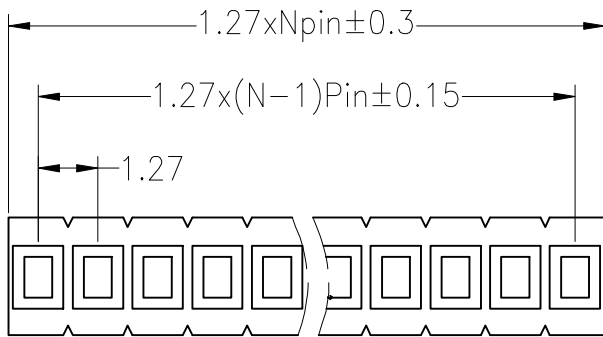

PIN 0.4*0.4

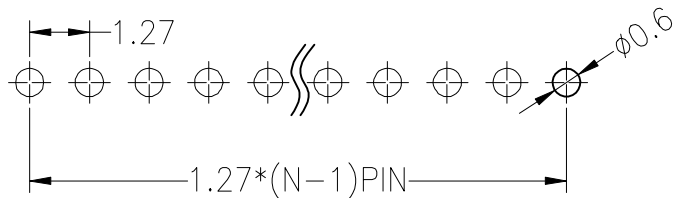
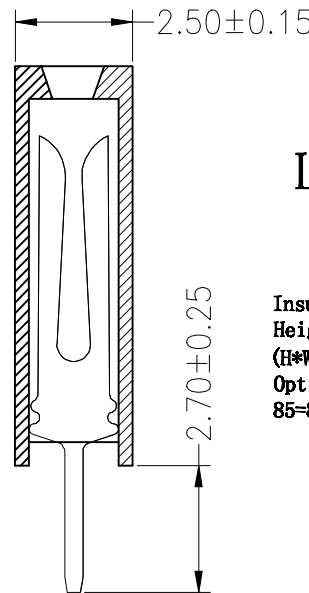

PCB LAYOUT

STANDARD TOLERANCE (EXCEPT SPECIFIED)			
LINER		ANGLES	
.0	±0.30	0.°	±3°
.00	±0.20	.0°	±2°
.000	±0.10	.00°	±1°

LDCONN 东莞连大精密制品有限公司 DongGuan LianDa Precision Products Co., LTD									
TITLE		PH1.27mm 1XNP 180° Single row Female Header Y Type		DRAWN BY		Lujunhui		18.03.30	
PART NO		L303XX-XX0XXXXX		CHECKED BY					
DRAWING NO				APPROVED BY					
SCALE	1:1	UNIT	mm		PAGE	1/1	SIZE	A4	